

Pro-V Mill



The Premium High-Speed Milling Tool for Aluminum

The New Premium Milling Tool Line for Aluminum Machining

- **Enhanced Productivity**
Increased productivity due to high speed capability
- **Improved Surface Finish**
Excellent surface finish and perpendicularity with high-precision products
- **Excellent Clamping Stability**
Satisfactory clamping force of inserts by the use of the key shape



Pro-V Mill

The Premium High-Speed Milling Tool for Aluminum

Pro-V Mill

KORLOY introduces a new premium milling product line for aluminum, Pro-V Mill. Development of this product has allowed high speed capability in aluminum machining, leading to an immense increase in productivity.

The huge impact given during high speed machining would change the position of the insert and cause tool breakage consequently. And the existing clamping method was not able to endure this impact. To overcome this kind of limit, a new clamping system has been applied. This new clamping method features enhanced clamping force at high speeds, providing reliable machining stability even when inserts get a shock.

KORLOY applied a new key to key slot clamping system to our new product, Pro-V Mill, in order to increase the clamping force. With stable cutting performance at high speed, it remarkably improves productivity and surface finish compared to the existing products.

Furthermore, the rake surface of the insert was treated with a mirror-like finish to avoid built-up edge issues. Various nose radius inserts are available to meet the needs of different applications.

Combined with the highly lubricative DLC grade PD1010, Pro-V Mill can improve the surface finish and product life.



Inserts



Cutters



Shanks

- Excellent clamping stability
 - **Strong clamping force at high speeds**
 - **Reduced vibrations and noises**



- Advanced productivity
 - **Higher table feed due to increased rpm**

- Improved surface finish
 - **Enhanced surface roughness and perpendicularity due to high speed capability**

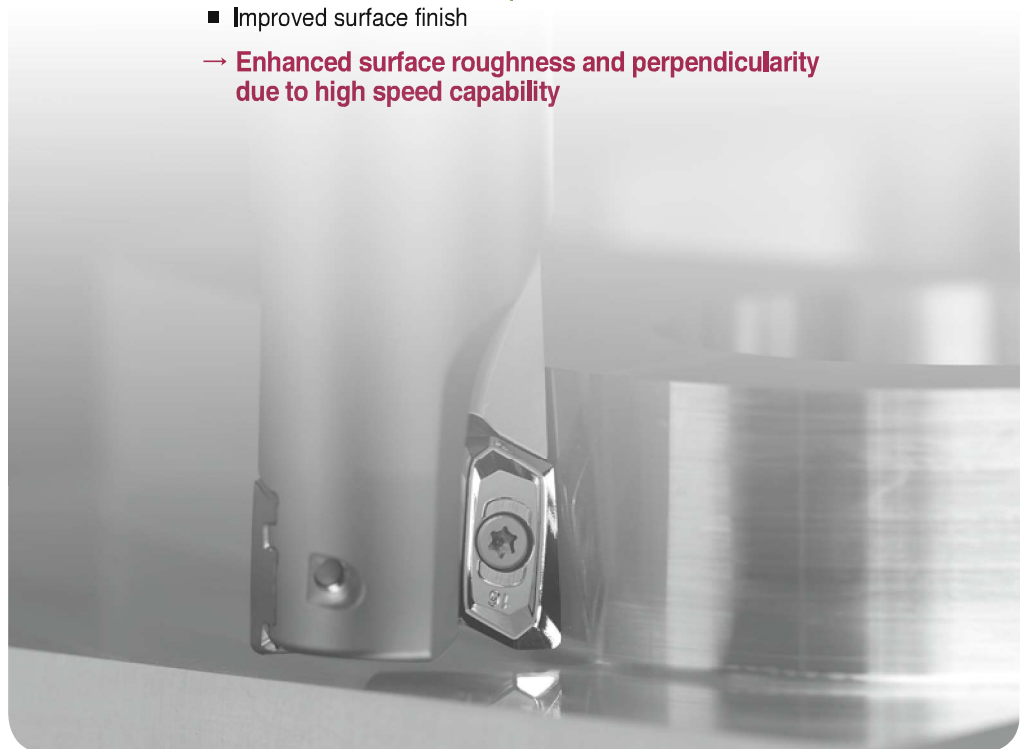

⇒ Code System

[Shank Type]

PAV S 032 R - 2 C 32 - 150 - XD19 - A				
Pro-V Mill	Machining Dia 032: Ø32	No. of teeth 2: 2 teeth	Shank Dia. 032: Ø32	Applicable insert XD19: XD19
Type S: Shank	Oil hole and hand R: Right hand with oil holes NR: Right hand without oil holes	Shank type C: Cylinder W: Weldon	Overall length 150: 150mm	Insert nose R A: Nose R 3.2 or lower B: Nose R 4.0 or higher

[Cutter Type]

PAV C M 050 R - 22 - 4 - XD19 - A				
Pro-V Mill	Arbor type M: Metric A: Inch None: Asia	Oil hole and hand R: Right hand with oil holes NR: Right hand without oil holes	No. of teeth 4: 4 teeth	Insert nose R A: Nose R 3.2 or lower B: Nose R 4.0 or higher
Type C: Cutter	Machining Dia. 050: Ø50	Internal Dia. 22: 22mm	Applicable insert XD19: XD19	

[Tooling System]

HSK63A - PAV 050 R - 4 - 100 - XD19 - A				
Arbor type	Machining Dia. 050: Ø50	No. of teeth 4: 4 teeth	Applicable insert XD19: XD19	Insert nose R A: Nose R 3.2 or lower B: Nose R 4.0 or higher
Pro-V Mill	Oil hole and hand R: Right hand with oil holes NR: Right hand without oil holes	Overall length 100: 100mm		

The combined clamping system of the key to key slot structure and simple screw-on type ensures strong clamping force

→ **Stable Machining / Prevention of insert breakage**

Avoiding uplifting problems of insert due to axial acute-angle clamping of cutters

→ **Reduced vibrations and excellent surface finish**

⇒ Cutter Features

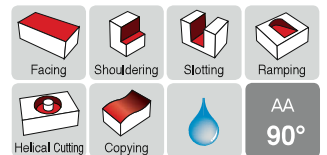

Screw-on clamping

New screw shape

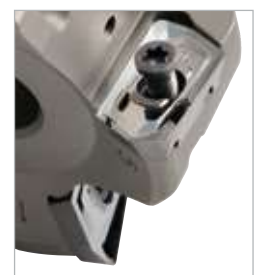

Axial acute-angle clamping

Inhibition of the axial force



Insert clamping area

Stable clamping force due to the key to key slot structure

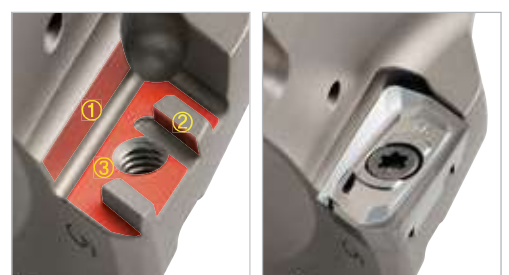

Pro-V Mill

➤ Insert Features

Wide minor cutting edges

- Improved surface finish

Mirror-like finish of the rake surface of insert

- Avoiding build-up edges through smooth chip flow



High-rake chip breaker and helix cutting edges

- High rake and lower cutting load



Application of the key slot design

- The bottom key of insert and the key slot in an acute angle
- High clamping stability of the holder contact area
→ Improved clamping force

➤ Chip Breaker Features

- Chip breaker
MA

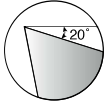

Chip breaker	Cutting-edge design	Application	Features
MA		For non-ferrous metals	<ul style="list-style-type: none"> ■ Ensuring satisfactory machining quality with the application of mirror-like cutting edges optimized for aluminum machining

➤ Recommended Cutting Conditions

Workpiece		Grade	vc (m/min)	Max. ap (mm)	
N	Aluminum			17	
		Si ≤ 5% (Si Lower than 5%)	H01		1300 (500-2200)
			H05		1000 (300-1700)
			PD1005		1500 (500-3000)
	Si ≤ 10% (Si Lower than 10%)	PD1010	1200 (300-2200)		

※ The recommended cutting conditions above are a general guideline.
Their details may vary depending on the machining method of users and other conditions.

AI Machining Tool Selection Guide

Selection system of tools

■ Pro-V Mill ■ Pro-X Mill ■ Pro-A Mill

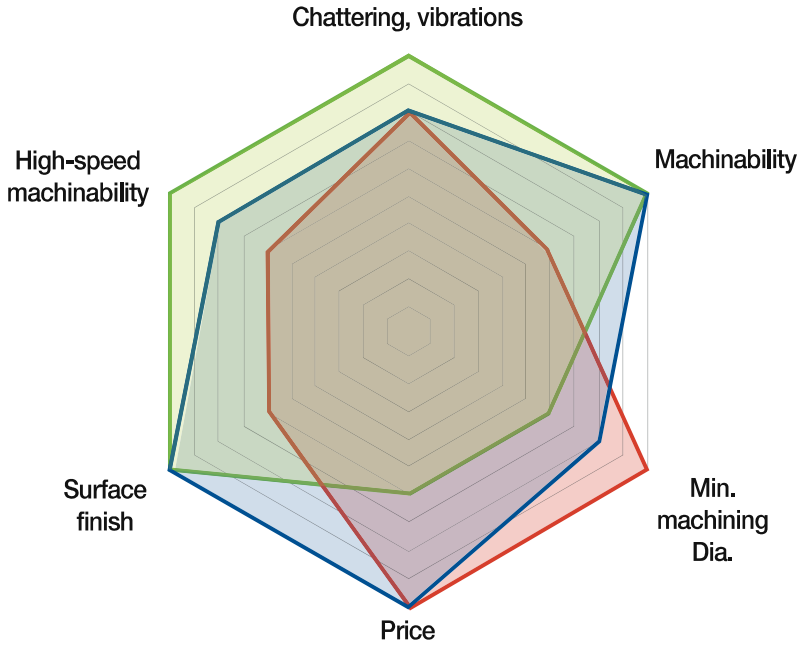

Pro-V Mill *New*

- Aluminum high-speed machining up to vc 3,000 (m/min)



Pro-X Mill

- Aluminum high-speed machining up to vc 2000 (m/min)



Pro-A Mill

- Small diameter machining Min. $\varnothing 0.5$



Product name	Chattering, vibrations	High-speed machinability	Machinability	Surface finish	Min. machining Dia.	Price
Pro-V Mill <i>New</i>	★★★★★	★★★★★	★★★★★	★★★★★	★★	★★
Pro-X Mill	★★★	★★★	★★★★★	★★★★★	★★★	★★★★★
Pro-A Mill	★★	★★	★★	★★	★★★★★	★★★★★

Application Range

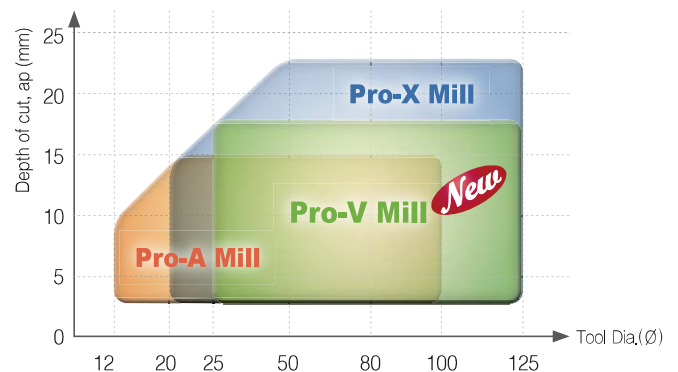
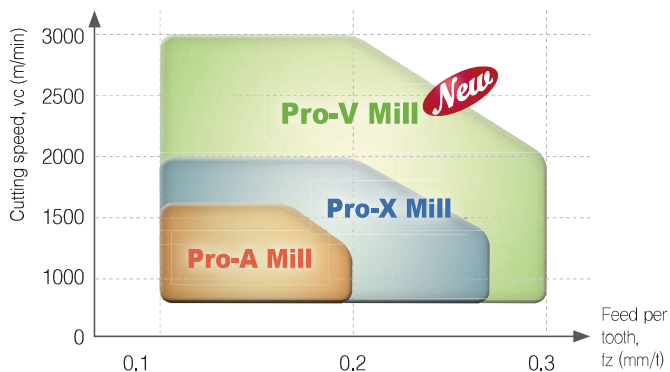

Pro-V Mill

Grades Selection Guide

- **PD1005**: for high speed, outstanding surface finish in the continuous cutting of general non-ferrous metals
- **PD1010**: provides stable and exceptional tool life when machining of non-ferrous metals with high hardness or interrupted machining

- **Uncoated carbide grade (H01/H05)**: a fine alloy structure suitable for cutting, with excellent wear resistance and toughness
- **DLC Grade (PD1005/PD1010)**: application of DLC coating with high hardness and reduced friction for high speed and superior surface roughness

Workpiece		ISO	Application range	
N	Aluminum, Copper	N05	H01	PD1005
		N10		
	Aluminum alloy	N15	H05	
		N20		
	Al-Si alloy	N25	PD1010	
		N30		

Hard H-DLC coating

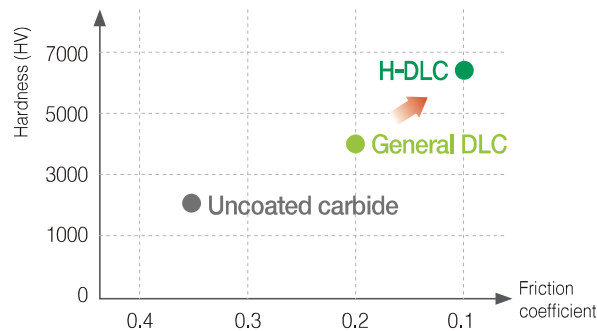

- Application of DLC (Diamond Liked Carbon) coating technology with high hardness and reduced friction
- Improved machinability and machining quality due to maximized wear resistance and lubrication
- Stable and long tool life due to substrate optimized for workpieces
- Suitable for machining of non-ferrous metal such as aluminum, Al-Si alloy, and copper

Hard H-DLC coating

DLC coating

- Diamond-Like Carbon
- Amorphous carbon coating with physical properties similar to those of diamonds
- High hardness and lubrication ideal for non-ferrous metal machining with a high probability of build-up edge occurring

DLC coating of high hardness

General DLC

- Hardness of coating: 3000 HV
- Friction coefficient: < 0.25

Hard DLC

- Hardness of coating: 6500 HV
- Friction coefficient: < 0.15

Rough coating surface

General DLC coating

Smooth coating surface

Hard DLC coating

Application Guideline for Grade

PD1005 / PD1010

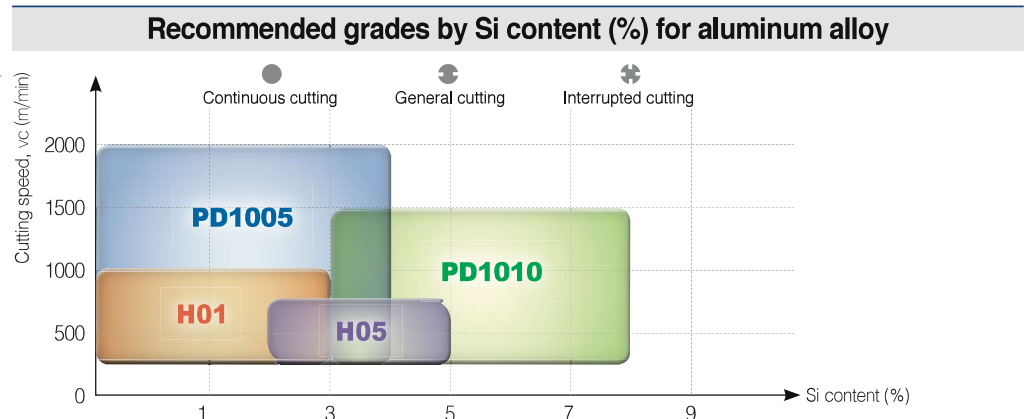
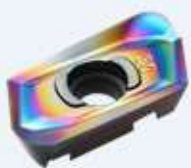

⇒ Performance Evaluation

- **Workpiece** AlZn5.5MgCu(ISO) / 7075(AISI) · rectangular Tube (300x200x100mm).
- **Cutting conditions** vc: 3560m/min · fz: 0,2 mm/gt · ap: 15mm · ae: 20mm · Wett
- **Machining method** Shouldering
- **Tools** Insert: XDET190508PEFR-MA (H01) Cutter Ø63: BT40-PAV063R-4-100-XD19-A

- Increased wear resistance of inserts due to stable clamping even in interrupted machining at high speeds
→ Longer tool life
- The cutting-edge design minimizes cutting resistance and reduces cutting noises and vibrations

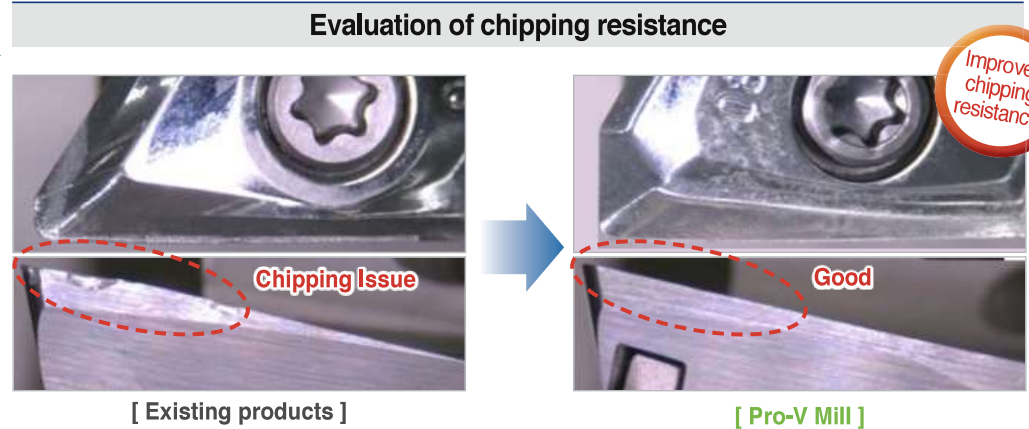

⇒ Perpendicularity Evaluation

- **Workpiece** AlZn5.5MgCu(ISO) / 7075(AISI) · rectangular Tube (300x200x100mm).
- **Cutting conditions** vc: 1000m/min · fz: 0,12mm/t · ap: 15mm · ae: 10mm · Wett
- **Machining method** Perpendicularity and shoulder surface finish checked after a single pass of 15 mm
- **Tools** WSP: XDET190508PEFR-MA (H01) Cutter Ø32: PAVS032R-2C32-150-XD19-A

- More stable clamping enables more stable machining
→ Improved perpendicularity

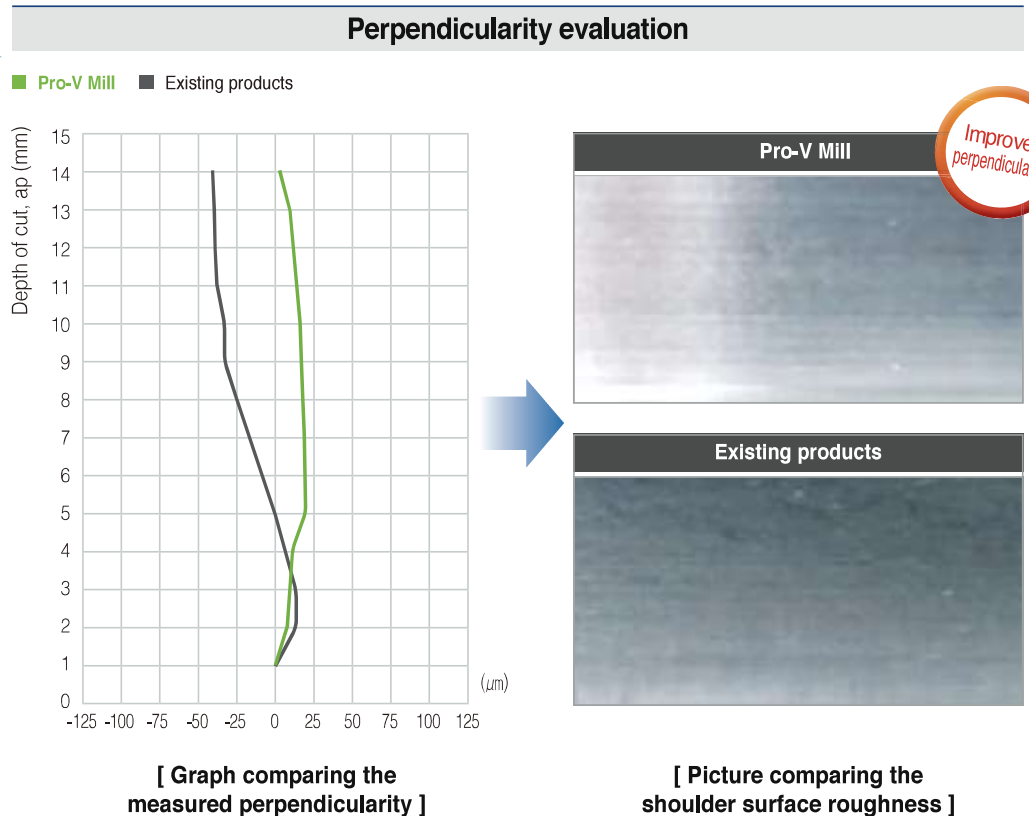

Pro-V Mill

➤ Ramping and Helical Cutting

1. Ramping

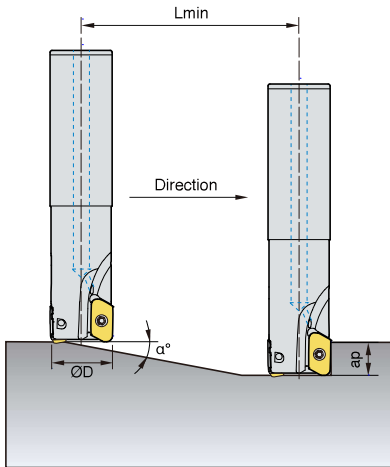

2. Helical cutting for blind hole

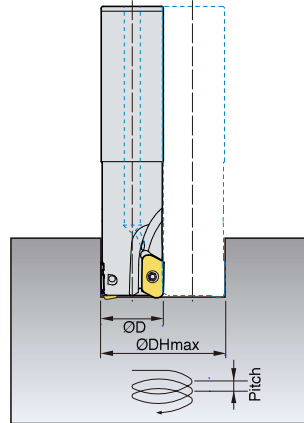

3. Helical cutting for through hole

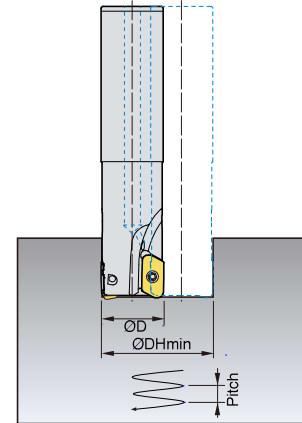

* Limits following Nose R 3.0 standard

(mm)

Tool Dia. ØD	1. Ramping		2. Helical cutting for blind hole				3. Helical cutting for through hole	
	Max. rake angle α°	Lmin	Min. machining Dia. ØDHmin	Max. pitch	Max. machining Dia. ØDHmax	Max. pitch	Min. machining Dia. ØDHmin	Max. pitch
25	15.0	59	41	13.0	44	15.5	27	2.0
32	10.0	99	55	11.0	58	12.5	41	4.5
40	7.0	142.5	71	10.5	74	11.5	57	6.0
50	5.0	200	91	10.0	94	10.5	77	6.5
63	3.5	286	117	9.2	120	9.5	103	7.0
80	2.6	385	151	9.0	154	9.5	137	7.3
100	2.0	501	191	9.0	194	9.0	177	7.6
125	1.5	668	241	8.5	244	8.5	227	7.5

- When ramping and helical milling, table feed, v_f (mm/min) should be lower than 70% of the recommended cutting conditions.
- When helical milling, Max. pitch, DHmax should be lower than max. depth of cut, ap.
- When ramping, the depth of cut should be lower than max. depth of cut, ap.

- $L_{min} = ap / \tan(\alpha^\circ)$ (mm)
- Lmin : Min. length of ramping
- ap : Depth of cut
- α° : Max. rake angle in ramping

➤ Applicable Inserts

Insert shape	Designation		Coated		Uncoated		Dimensions (mm)					Figure
			PD1005	PD1010	H01	H05	l	d	t	r	d ₁	
	XDET	190504PEFR-MA	N				22	11.3	5.04	0.4	4.5	
		190508PEFR-MA					22	11.3	5.00	0.8	4.5	
		190512PEFR-MA					22	11.3	5.00	1.2	4.5	
		190516PEFR-MA					22	11.3	4.99	1.6	4.5	
		190520PEFR-MA					22	11.3	4.97	2.0	4.5	
		190524PEFR-MA					22	11.3	4.95	2.4	4.5	
		190530PEFR-MA					22	11.3	4.93	3.0	4.5	
		190532PEFR-MA					22	11.3	4.92	3.2	4.5	
		190540PEFR-MA					21	11.3	4.85	4.0	4.5	
		190550PEFR-MA					21	11.3	4.81	5.0	4.5	

Designation	Image	A.A.	Diameter range	Insert	ap	Application				
						Facing	Shouldering	Slotting	Copying	Ramping-Helical
PAVCM-A		90°	Ø40 - Ø125	XDET19	17 mm	●	●	●	●	●

* Type A uses Insert Nose R 0,4-3,2, and Type B uses Nose R 4,0 - 5,0

* When using a spindle at high speed, please check the balance of tool and use it after replacing with the new screw.

Designation	Image	A.A.	Diameter range	Insert	ap	Application				
						Facing	Shouldering	Slotting	Copying	Ramping-Helical
PAVS-A		90°	Ø25 - Ø40	XDET19	17 mm	●	●	●	●	●



* Type A uses Insert Nose R 0.4-3.2, and Type B uses Nose R 4.0 - 5.0

* When using a spindle at high speed, please check the balance of tool and use it after replacing with the new screw.

Designation	Image	A.A.	Diameter range	Insert	ap	Application				
						Facing	Shouldering	Slotting	Copying	Ramping-Helical
HSK63A-PAV		90°	Ø32 - Ø50	XDET19	17 mm	●	●	●	●	●

* Type A uses Insert Nose R 0.4-3.2, and Type B uses Nose R 4.0 - 5.0

* When using a spindle at high speed, please check the balance of tool and use it after replacing with the new screw.

Specification	Screw	Wrench
Ø40 ~ Ø125	 PTKA0408-A	 TW15S

Notice

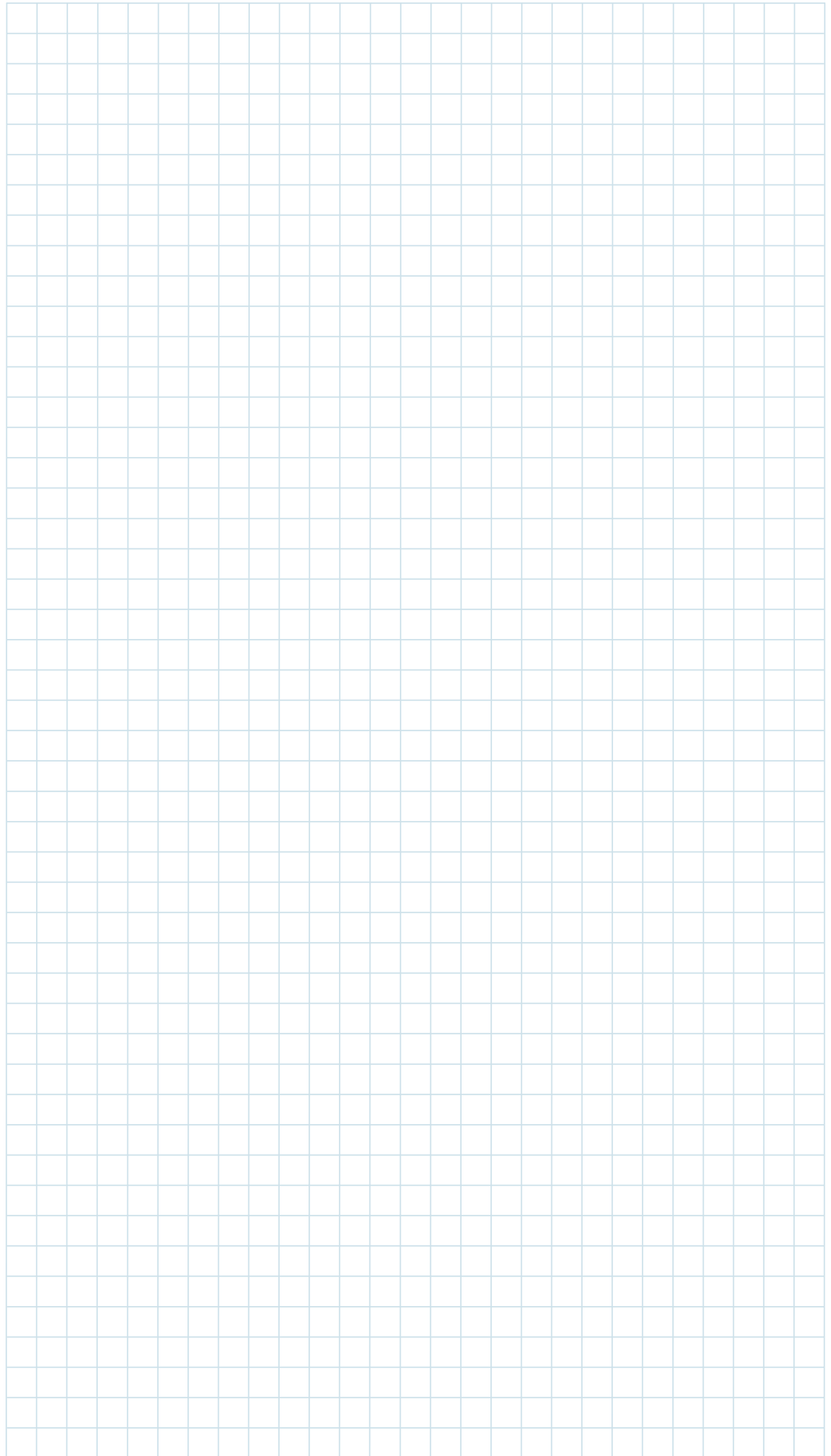

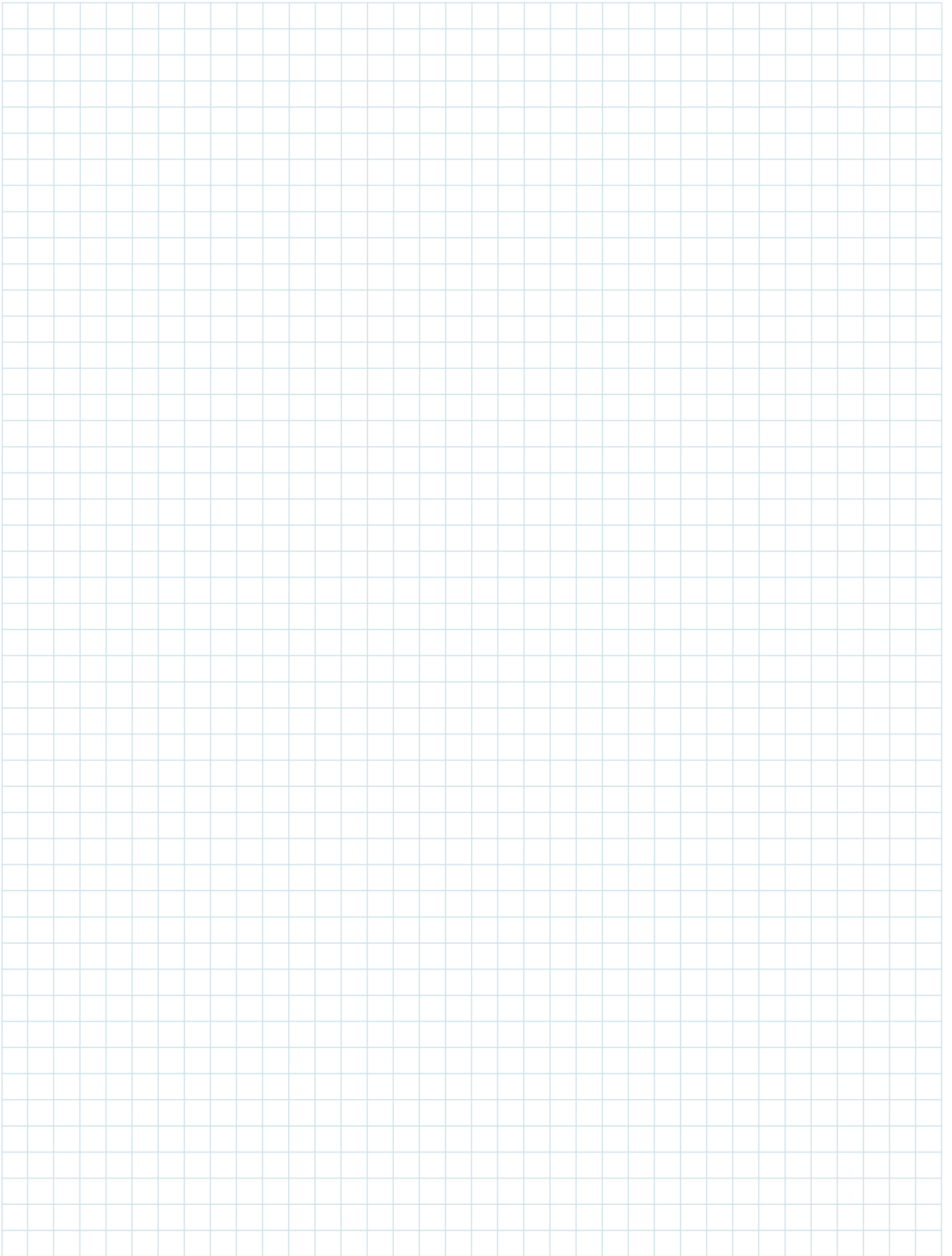

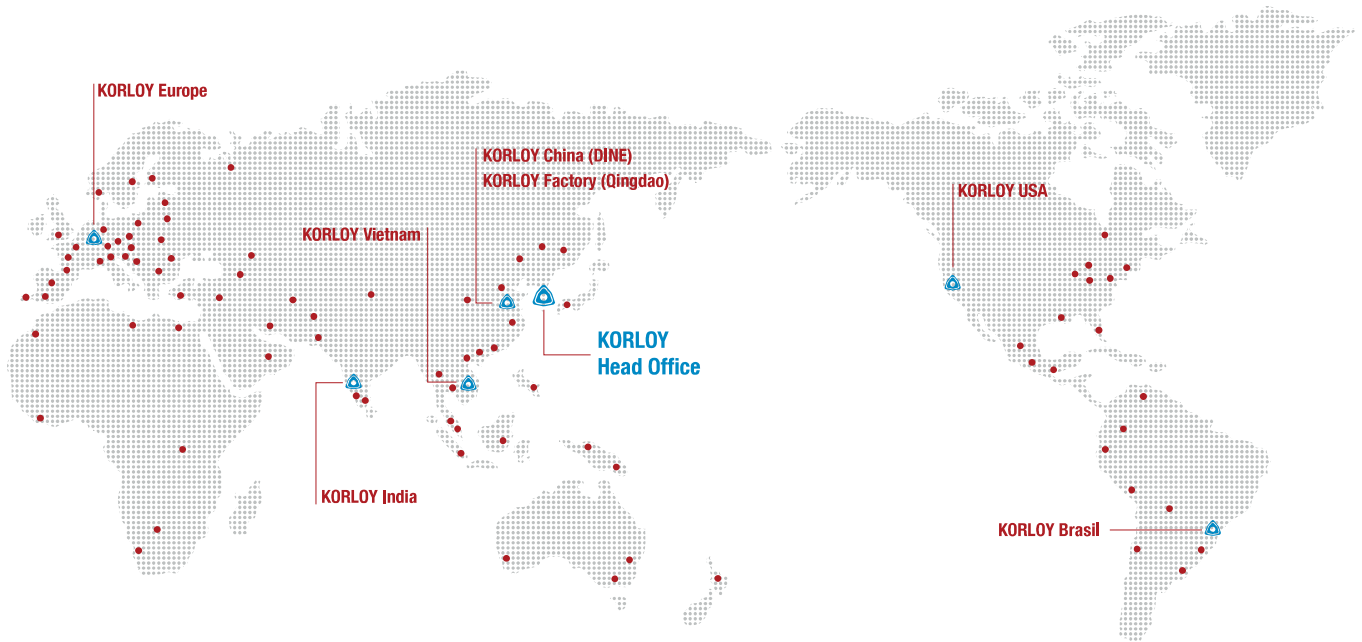

Head Office

Holystar B/D, 1350, Nambusunhwan-ro, Geumcheon-gu, Seoul, 08536, Korea Web: www.korloy.com

Cheongju Factory

55, Sandan-ro, Heungdeok-gu, Cheongju-si, Chungcheongbuk-do, 28589, Korea

Jincheon Factory

54, Gwanghyewonsandan 2-gil, Gwanghyewon-myeon, Jincheon-gun, Chungcheongbuk-do, 27807, Korea

R & D Institute Cheongju

55, Sandan-ro, Heungdeok-gu, Cheongju-si, Chungcheongbuk-do, 28589, Korea

R & D Institute Seoul

Holystar B/D, 1350, Nambusunhwan-ro, Geumcheon-gu, Seoul, 08536, Korea



KORLOY EUROPE

Gablonzer Straße 25-27, D-61440 Oberursel, Germany, Tel: +49-6171-27783-0, Fax: +49-6171-27783-59
E-Mail: info@korloyeurope.com, Web: www.korloyeurope.com



KORLOY AMERICA

620 Maple Avenue, Torrance, CA 90503, USA



KORLOY INDIA

Ground Floor, Property No. 217, Udyog Vihar Phase 4, Gurgaon 122016, Haryana, India



KORLOY BRASIL

Av. Aruana 280, conj.12, WLC, Alphaville, Barueri, CEP06460-010, SP, Brasil



KORLOY VIETNAM

No. 133 Le Loi street, Hoa Phu ward, Thu Dau Mot city, Binh Duong proviende, Vietnam



KORLOY FACTORY QINGDAO

Ground Dongjing Road 56 District Free Trade Zone, Qingdao, China



KORLOY FACTORY INDIA

Plot No. 415, Sector 8, IMT Manesar, Gurgaon 122051, Haryana, India

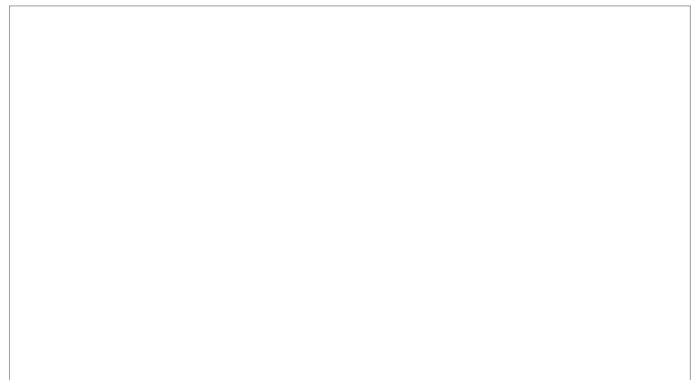

KTS - Korloy Tooling Solution



Get our **FREE App**

Just download, install and use.

