

YOUNG

CUTTINGTOOLS

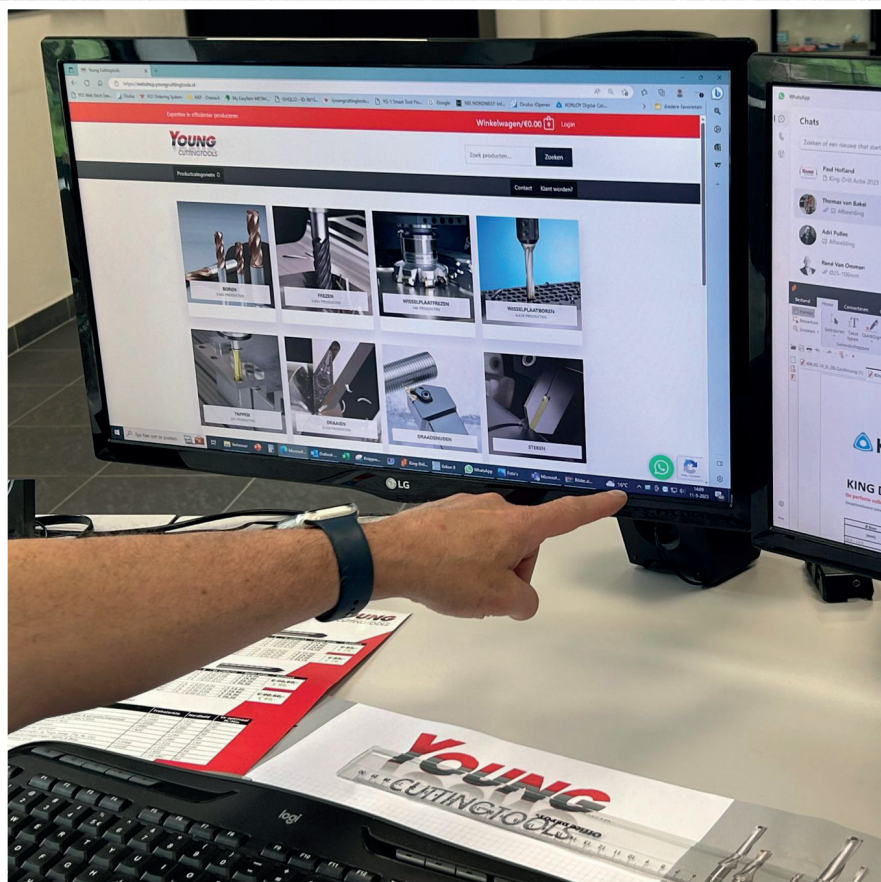

WHATSAPP
BINNENDIENST
+31-06-17714749

vraag het ons via WhatsApp!

Snel en effectief antwoord op uw vraag? Maak dan gebruik van onze WhatsApp-service! Vragen over bestellingen, producten, handleidingen of een technische tekening? Op werkdagen gegarandeerd een snel antwoord. Kies +31-06-17714749, scan de QR code of gebruik de WhatsApp-knop op onze website.



GERARDI MODULAIRE PRECISIE MACHINEKLEM

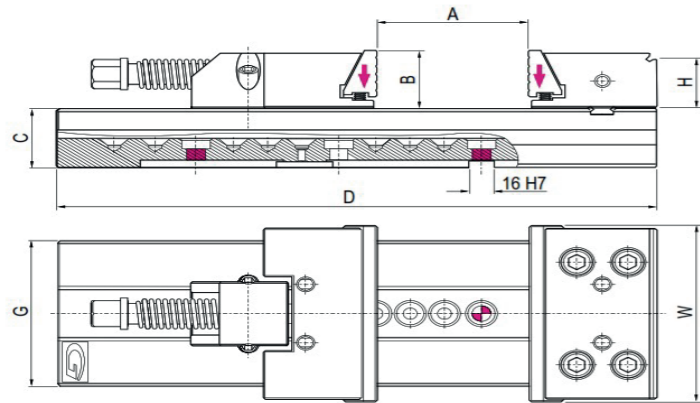

Afmetingen	Type 3 30 kN	Normaal	Actieprijs
A max.	300	€ 843,-	ACTIE € 665,-
W	150		
B	50		
C	50		
D	520		
G	125		
kg	29		
Artikel	3.03.3000		

* PRIJS IS INCLUSIEF:

- 1 stuk werkstukaanslag Art. 370
- 4 stuks opspanblokken Art. 298 t.w.v. € 72,-
- 1 set positioneerblokje Art. 297
- 1 spansleutel Art. 3751 zeskant stelsleutel Art. 376
- 1 set positioneer blokje: voor T-gleuf 16mm

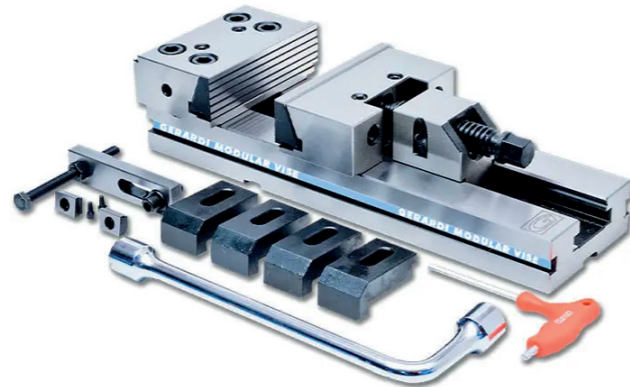

DE MEEST POPULAIRE EN GEKOPIERDE MACHINEKLEM TER WERELD!

De modulaire precisie machineklem van Gerardi mag je gerust een pronkstuk noemen in de wereld van verspaning. Gerardi begon al veertig jaar geleden met de ontwikkeling van deze klem en het is nog altijd het meest verkochte en gekopieerde product.



AANGEDREVEN HOUDERS

COMPATIBEL MET:



AXIAAL

BMT	Code	ER	H	Nm	Rpm
45	99.DS.A03	25	Max.57,2	35	8000
	99.DS.A04	25	Max.57,2	35	8000
55	99.DS.A01	25	Max.57,2	40	8000
	99.DS.A02	25	Max.57,2	40	8000
65	99.DS.A41	32	Max.72,5	70	6000
	99.DS.A42	32	Max.72,5	70	6000
75	99.DS.A34	40	Max.90,2	100	6000
	99.DS.A35	40	Max.90,2	100	6000



RADIAAL

BMT	Code	ER	H	Nm	Rpm
45	99.DS.A07C	25	65	35	8000
	99.DS.A08C	25	65	35	8000
55	99.DS.A11C	25	70	40	8000
	99.DS.A12C	25	70	40	8000
65	99.DS.A51C	32	72	70	6000
	99.DS.A52C	32	72	70	6000
75	99.DS.A38C	40	60	100	6000
	99.DS.A39C	40	60	100	6000



VERSTELBAAR

BMT	Code	ER	H	Nm	Rpm
45	99.DS.A16	20	65	15	8000
	99.DS.A17	20	65	15	8000
55	99.DS.A23	20	65	15	8000
	99.DS.A66	20	65	15	8000
65	99.DS.A64	25	75	25	6000
	99.DS.A65	25	75	25	6000
75	99.DS.A47	25	75	25	6000
	99.DS.A48	25	75	25	6000

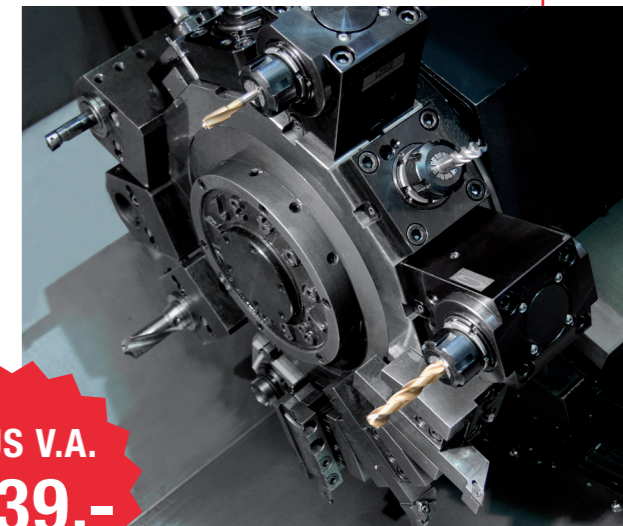

PRIJS V.A.
€ 839,-



SPANTANGHOUDERS ER

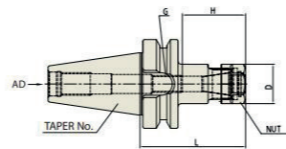
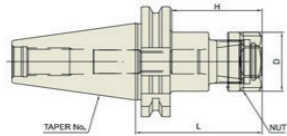

DIN 69871 -SK	Taper Accuracy AT3	G Value 6.3	RPM 15,000	Coolant System AD
---------------	--------------------	-------------	------------	-------------------

JIS B6339 -BT	Taper Accuracy AT3	G Value 6.3	RPM 15,000	Coolant System AD
---------------	--------------------	-------------	------------	-------------------

Artikelnummer	Model	Actieprijs
P2776417	SK40AD - ER16 - 70	€ 30,00
P2527018	SK40AD - ER16 - 100	€ 35,00
P2776418	SK40AD - ER20 - 70	€ 30,00
P2527019	SK40AD - ER20 - 100	€ 35,00
P2776419	SK40AD - ER25 - 70	€ 30,00
P2776429	SK40AD - ER25 - 100	€ 35,00
P2776420	SK40AD - ER32 - 70	€ 30,00
P2776430	SK40AD - ER32 - 100	€ 35,00
P2527011	SK40AD - ER40 - 80	€ 35,00

Artikelnummer	Model	Actieprijs
P2772101	BT40AD - ER16 - 75	€ 30,00
P2772118	BT40AD - ER16 - 100	€ 35,00
P2772102	BT40AD - ER20 - 75	€ 30,00
P2772120	BT40AD - ER20 - 100	€ 35,00
P2772103	BT40AD - ER25 - 75	€ 30,00
P2772122	BT40AD - ER25 - 100	€ 35,00
P2772104	BT40AD - ER32 - 60	€ 30,00
P2772125	BT40AD - ER32 - 100	€ 35,00
P2772127	BT40AD - ER40 - 80	€ 35,00



ER 8 P2506301		ER 11 P2506302		ER 16 P2506303		ER 20 P2506304	
STANDAARD SET	208000	STANDAARD SET	211000	STANDAARD SET	216000	STANDAARD SET	220000
Ø 1.0 - 5.0mm		Ø 1.0 - 7.0mm		Ø 1.0 - 10.0mm		Ø 2.0 - 13.0mm	
9pcs		13pcs		10pcs		12pcs	
€ 89,-		€ 115,-		€ 89,-		€ 105,-	
CASSETTE ZWT 8	108110	CASSETTE ZWT 11	011110	CASSETTE ZWT 16	016110	CASSETTE ZWT 20	020110

ER 25 P2506305		ER 32 P2506306		ER 40 P2506307		ER 50 P2506308	
STANDAARD SET	225000	STANDAARD SET	232000	STANDAARD SET	240000	STANDAARD SET	250000
Ø 2.0 - 16.0mm		Ø 3.0 - 20.0mm		Ø 4.0 - 26.0mm		Ø 12.0 - 34.0mm	
15pcs		18pcs		23pcs		12pcs	
€ 133,-		€ 166,-		€ 230,-		€ 280,-	
CASSETTE ZWT 25	025110	CASSETTE ZWT 32	032110	CASSETTE ZWT 40	040110	CASSETTE ZWT 50	050110

ER SPANTANGSLEUTELS



Artikelnummer	Model	Actieprijs
P2772601	SLEUTEL ER11 (fig.1)	€ 7,50
P2772602	SLEUTEL ER16 (fig.1)	€ 7,50
P2772603	SLEUTEL ER20 (fig.1)	€ 7,50
P2772604	SLEUTEL ER25 (fig.2)	€ 7,50
P2772605	SLEUTEL ER32 (fig.2)	€ 7,50
P2772606	SLEUTEL ER40 (fig.2)	€ 7,50

Artikelnummer	Model	Actieprijs
P2772612	SLEUTEL ER50 (fig.2)	€ 8,50
P2772608	SLEUTEL MINI ER8	€ 11,00
P2772609	SLEUTEL MINI ER11	€ 11,00
P2772610	SLEUTEL MINI ER16	€ 11,00
P2772611	SLEUTEL MINI ER20	€ 13,00
P2772607	SLEUTEL MINI ER25	€ 13,00

OPSTEEKHOUDERS

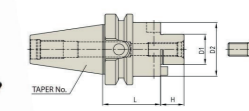
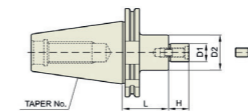

DIN 69871 -SK	Taper Accuracy AT3	G Value 6.3	RPM 15,000	Coolant System AD
---------------	--------------------	-------------	------------	-------------------

JIS B6339 -BT	Taper Accuracy AT3	G Value 6.3	RPM 15,000	Coolant System AD
---------------	--------------------	-------------	------------	-------------------

Artikelnummer	Model	Actieprijs
P2778904	SK40AD - SMA16-60	€ 35,00
P2778905	SK40AD - SMA22-60	€ 35,00
P2778906	SK40AD - SMA27-60	€ 37,00
P2778907	SK40AD - SMA32-60	€ 39,00
P2778908	SK40AD - SMA40-60	€ 49,00

Artikelnummer	Model	Actieprijs
P2778804	BT40AD - SMA16-60	€ 35,00
P2778805	BT40AD - SMA22-60	€ 35,00
P2778806	BT40AD - SMA27-60	€ 37,00
P2778807	BT40AD - SMA32-60	€ 39,00
P2778808	BT40AD - SMA40-60	€ 49,00

WELDONHOUDERS

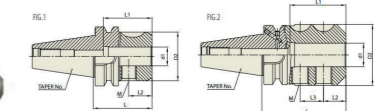
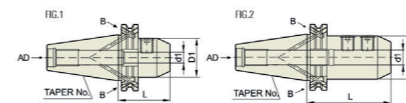

DIN 69871 -SK	Taper Accuracy AT3	G Value 6.3	RPM 15,000	Coolant System AD
---------------	--------------------	-------------	------------	-------------------

JIS B6339 -BT	Taper Accuracy AT3	G Value 6.3	RPM 15,000	Coolant System AD
---------------	--------------------	-------------	------------	-------------------

Artikelnummer	Model	Actieprijs
P2521009	SK40AD - EMH6-50	€ 25,00
P2521010	SK40AD - EMH8-50	€ 25,00
P2521011	SK40AD - EMH10-50	€ 25,00
P2521012	SK40AD - EMH12-50	€ 25,00
P2521013	SK40AD - EMH16-63	€ 25,00
P2521014	SK40AD - EMH20-63	€ 25,00
P2521015	SK40AD - EMH25-100	€ 31,00
P2521016	SK40AD - EMH12-100	€ 33,00

Artikelnummer	Model	Actieprijs
P2773061	BT40AD - EMH6-50	€ 25,00
P2773062	BT40AD - EMH8-50	€ 25,00
P2773063	BT40AD - EMH10-63	€ 25,00
P2773064	BT40AD - EMH12-63	€ 25,00
P2773066	BT40AD - EMH16-63	€ 25,00
P2773068	BT40AD - EMH20-63	€ 25,00
P2773069	BT40AD - EMH25-90	€ 31,00
P2773070	BT40AD - EMH32-100	€ 33,00

WISSELPLATEN

MIX & MATCH

YG-1 ISO-wisselplaten voor draaien.

- Geschikt voor: staal, RVS, aluminium en andere materiaalsoorten.
- Diverse mogelijkheden in geometrieën (t/m 16 mm), spaanbrekers en coatings.

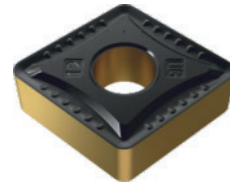

Met de nieuwe coating YG3030 worden zeer goede resultaten behaald!

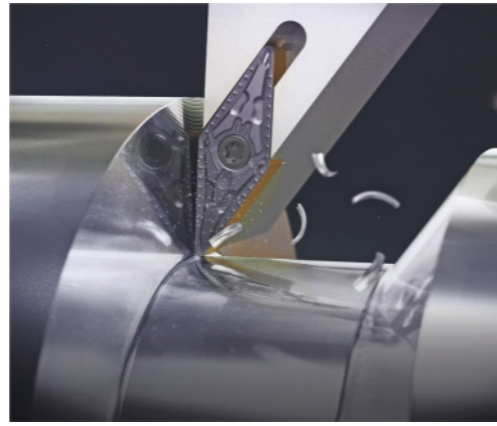

**5 DOOSJES HALEN
4 DOOSJES BETALEN**

DRAAIPLATEN

NEGATIEVE WISSELPLATEN				POSITIEVE WISSELPLATEN			
Vorm	Type	Grootte		Vorm	Type	Grootte	
C	CNMA CNMG	12 12	16	C	CCGT CCMT	06 09 12	09 12
D	DNMA DNMG	1504	1506 1506	D	DCGT DCMT	07	11 11
S	SNMA SNMG	12 12		R	RCMT	06	08 10 12
T	TNMA TNMG	16 16		S	SCMT	09	12
V	VNMG	16		T	TCGT TCMT	11	16 16
W	WNMA WNMG	06	08 08	V	VBMT VCGT/VCMT	16	16

TURNING GRADES ISO Turning

Turning Grades	P Steel				M Stainless steel			K Cast iron			N Non-ferrous metals		S Superalloys & Titanium		H Hard Materials	
	10	20	30	40	10	20	30	10	20	30	10	20	10	20	10	20
CVD																
YG1010								1010								
YG1001	1001							1001								
YG3010		3010						3010								
YG3015			3015													
YG3020				3020												
YG3030					3030											
PVD																
YG801		801														
YG211					211											
YG213						213										
YG214							214									
YG401													401			
DLC																
YG100									100							
YG10										10						

- NEW YG1010** [K05-K15] (2020, Sep.)
Excellent Wear Resistance can provide high Productivity with better Tool life
- YG1001** [P01-P10] [K10-K25]
Hard grade for High Productivity in Stable Application
Grey Cast Iron & Steel Finishing
- YG3010** [P05-P20] [K15-K25]
First Choice for Steel Finishing & Ductile Cast Iron
- NEW YG3015** [P10-P25] (2020, Mar.)
Medium to Finishing
Versatility in Stable Application
- YG3020** [P15-P30]
High Versatility
Roughing to Finishing
- YG3030** [P20-P35] [M10-M30]
Tough grade for Safety Machining
Interrupted cut for Steel and High Cutting speed for Stainless steel
- YG211** [M05-M25] [S15-S25]
Finishing & Semi Finishing
Stainless steel and Superalloys
- YG213** [M20-M35] [S25-S30]
First choice for Stainless steel on low cutting speed
- YG214** [M30-M40] [S30-S35]
For Very Unstable Machining in Stainless steel
- NEW YG401** [S10-S20] (2020, Jun.)
First choice for HRSA (Heat Resistance Super Alloys)
- YG100** [N05-N25]
High Performance DLC grade for Aluminum with 12% ≤ Si
- YG10** [N05-N25]
Uncoated grade for General Aluminum
- YG801** [P10-P30]
Low cutting speed & Fine Finishing

BORENSET



€ 99,-

- Kruisaanslijping zelfcentrerend
- Geschikt voor rvs, gelegeerde en ongelegeerde staalsoorten
- Hoge standtijden

Premium HSS-E geslepen boren DIN338 met TIN-tip coating
Inhoud: 25 stuks 1-13 (0.5mm oplopend)
Bestelnummer: DLG195SET2

BOOR / TAP SET



€ 79,-

- HSS Stoom ontladen
- Geschikt voor gelegeerde en ongelegeerde staalsoorten

Universeel boren/tappenset:
Inhoud: HSS-E Combo tappen M3, M4, M5, M6, M8, M10, M12
Inhoud: HSS-E Goldpoint boren Ø2.5, 3.3, 4.2, 5.0, 6.8, 8.5, 10.2
Bestelnummer doorlopend: TC814SET-DLGP
Bestelnummer blind: TC804SET-DLGP

STIFTFREZEN SET



€ 119,-

- Geschikt voor gelegeerde en ongelegeerde staalsoorten
- Schacht 6mm
- Hoge standtijden

Inhoud: Assortiment 10 stuks (6 t/m 12mm)
Bestelnummer: SETRB10

VERZINKBOREN SET



€ 99,-

- Geschikt voor gelegeerde en ongelegeerde staalsoorten
- Schacht 6mm
- Hoge standtijden

YG-1 HSS-Co8 Verzinkborensset 90° met TiAlN coating (8% Cobalt)
Inhoud: 6.3 | 8.3 | 10.4 | 12.4 | 16.5 | 20.5 | 25
• Bestelnummer: C1339S70
• Geschikt voor rvs, gelegeerde-, ongelegeerde staalsoorten
• Hoge standtijden

HSS-E TAPPENSET



€ 59,-

- YG-1 speciale gepatenteerde geometrie
- Uitstekende prestaties in meerdere materialen (staal, rvs)
- Voor perfect gevormde schroefdraad
- Hoge standtijden

Inhoud: M3 | M4 | M5 | M6 | M8 | M10 | M12
Bestelnummer doorlopend: TC814SET7
Bestelnummer blind: TC804SET7

HSS-PM TAPPENSET



€ 99,-

- YG-1 Prime tappenserie
- YG-1 speciale gepatenteerde geometrie
- Uitstekende prestaties in meerdere materialen (staal, rvs)
- Voor perfect gevormde schroefdraad
- Hoge standtijden

HSS-PM machinetappen
Inhoud: M3|M4|M5|M6|M8|M10|M12
Bestelnummer doorlopend: TRJ15GSSET7
Bestelnummer blind: TRE30GSSET7

KING DRILL ACTIE

DE PERFECTE VOLBOOR VOORZIEN VAN WISSELPLATEN MET 4 SNIJKANTEN

Geoptimaliseerd ontwerp wisselplaatboor voor maximale boorefficiëntie.

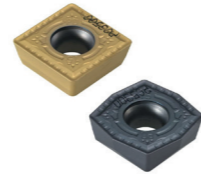

Ø Boor (mm)	Grootte wisselplaat	Aantal wisselplaten		Lengte van de boor			
		Buiten 10x	Centrum 10x	2xD	3xD	4xD	5xD
12.0 - 13.5	4	SPMT040204-PD	XOMT040204-PD	€ 298,00	€ 298,00	€ 315,00	€ 401,00
14.0 - 16.0	5	SPMT050204-PD	XOMT050204-PD	€ 332,50	€ 332,50	€ 352,00	€ 449,00
16.5 - 19.5	6	SPMT060205-PD	XOMT060204-PD	€ 333,50	€ 333,50	€ 353,00	€ 450,00
20.0 - 23.5	7	SPMT07T208-PD	XOMT07T205-PD	€ 347,50	€ 347,50	€ 368,00	€ 472,00
24.0 - 29.5	9	SPMT090308-PD	XOMT090305-PD	€ 373,00	€ 373,00	€ 396,00	€ 508,00
30.0 - 35.5	11	SPMT11T308-PD	XOMT11T306-PD	€ 421,00	€ 421,00	€ 446,50	€ 573,50
36.0 - 42,5	13	SPMT130410-PD	XOMT130406-PD	€ 443,00	€ 443,00	€ 518,00	€ 604,00
43,0 - 50.5	15	SPMT15M510-PD	XOMT15M508-PD	€ 486,50	€ 486,50	€ 563,00	€ 669,00
51.0 - 60.5	18	SPMT180510-PD	XOMT180508-PD	€ 546,00	€ 546,00	€ 579,50	€ 748,00

Ø61-100 op aanvraag

* Actiesets zijn compleet 1 houder, 10 centrum- en 10 buitenwisselplaten.

** Coating van de wisselplaten zijn naar keuze.

*** Prijzen voor aluminium wisselplaat op aanvraag.



ALUMINIUM FREZEN



Speciaal voor aluminium en kunststoffen
Vraag vrijblijvend om een demonstratie



Type	ØD	ØD2	Ød	Ød1	Ød2	a	b	E	F	Max rpm	ap	kg		
PAXCM	5040HR-A,B	3	40	34	16	9	14	8.4	5.6	19	40	25,800	17	0.15
	5050HR-A,B	4	50	42	22	11	18	10.4	6.3	21	50	23,000	17	0.3
	5063HR-A,B	5 (4)	63	49	22	11	18	10.4	6.3	21	50	20,500	17	0.56
PAXC (PAXCM)	5080HR-A,B	5	80	57	25.4 (27)	14	20	9.5 (12.4)	6 (7)	2.4 (23)	50	18,200	17	1.0
	5100HR-A,B	6	100	67	31.75 (32)	18	26	12.7 (14.4)	8 (8)	32 (26)	63	16,300	17	2.3
	5125HR-A,B	7	125	87	38.1 (40)	22	32	15.9 (16.4)	10 (9)	35 (29)	63	14,600	17	3.2

* A-Type: geschikt voor neusradius 0.4 - 3.2, B-Type geschikt voor neusradius 4.0 - 5.0

NC SPOT DRILL

Één gereedschap voor meerdere toepassingen

- Graveren, centreren, afkanten en v-groeven
- Hoge standtijd
- Elke wisselplaat heeft 2 of 4 snijkanten
- 45° / 60° / 82° / 90° / 100° / 120° / 142° Hoek voor verschillende toepassingen



ACTIE
€ 199,-

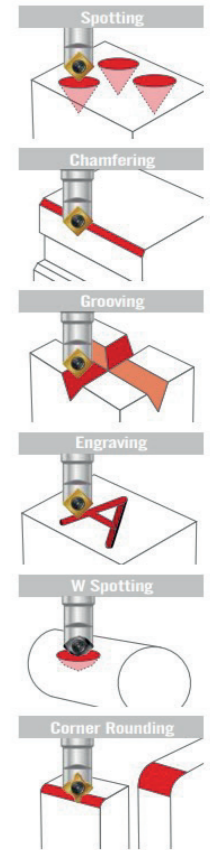

DRAAIMOMENT SCHROEVENDRAAIERSET TORX, 25MM + 50MM BITS SLOKY

ACTIE
€ 149,-

Artikelnummer	Handgreep	Inhoud				Bit 25mm + 50mm
		Grootte	Nm	Kgfm	In-lb	
0-TPK01-TGTX-12K	O-TPK-H02-R	TX06	0.6	6.1	5.3	ACTIE € 149,-
		TX07	0.9	9.2	8.0	
		TX08	1.2	12.0	10.6	
		TX09	1.4	14.0	12.4	
		TX10	2.0	20.4	17.7	
		TX15	3.0	30.6	26.6	



HIGH PERFORMANCE VHM FREES 6-SNIJDER 6 SNIJDERS / LANG MODEL



GMG12 CILINDRISCH

GMG13 WELDON

- Unieke geometrie van de variabele helix, zeer geschikt voor hoge snelheid en trochoïdaal frezen
- Uitstekende prestaties voor RVS, zacht staal, gietijzer, materialen met een lage/middelharde hardheid onder HRc40

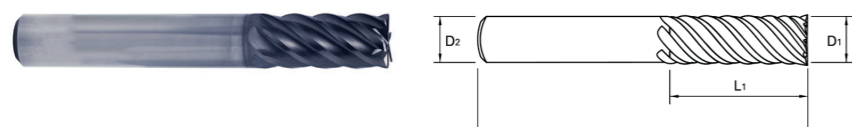

Artikelnummer		Frees diameter	Schacht diameter	Snijlengte	Totaal lengte	Actie prijs
CILINDRISCH	WELDON					
GMG12060	GMG13060	6.0	6	13	57	€ 24,00
GMG12080	GMG13080	8.0	8	19	63	€ 34,00
GMG12100	GMG13100	10.0	10	22	72	€ 54,00
GMG12120	GMG13120	12.0	12	26	83	€ 73,50
GMG12160	GMG13160	16.0	16	32	92	€ 131,00
GMG12200	GMG13200	20.0	20	38	104	€ 232,00
GMG12250	GMG13250	25.0	25	44	104	€ 327,00

**COMPLETE SET:
6 + 8 + 10 + 12 + 16mm**

**ACTIE
€ 299,-**

TANKPOWER HSS-PM FREZEN



UNCOATED **E9A26 SERIES**
TiAIN based COATED **GAA26 SERIES**

HSS-PM, multi-snijder 45° Helix, fijn ruw frees

- Hoge spaanafvoer en minimale breuk van snijkanten
- Ontworpen om koolstofstaal, gelegeerd staal en roestvrij staal te bewerken
- YG-1's nieuw ontwikkelde Tank-Power coating geschikt voor hoge snijnsnelheden



Artikel nummer	Frees diameter	Schacht diameter	Snijlengte	Nek lengte	Totaal lengte	Nek diameter	Aantal tanden	Fase	Actie prijs
X-COATING	D1	D2	L1		L2				
GAA26040	4.0	6	11	-	57	-	3	0.1	€ 25,00
GAA26050	5.0	6	13	-	57	-	4	0.13	€ 25,00
GAA26060	6.0	6	13	-	57	-	4	0.15	€ 25,00
GAA26070	7.0	10	16	-	66	-	4	0.15	€ 33,50
GAA26080	8.0	10	19	-	69	-	4	0.18	€ 33,50
GAA26090	9.0	10	19	-	69	-	4	0.18	€ 33,50
GAA26100	10.0	10	22	31	72	9.5	4	0.20	€ 34,50
GAA26120	12.0	12	26	37	83	11.5	4	0.20	€ 42,00
GAA26140	14.0	12	26	-	83	-	5	0.20	€ 49,50
GAA26160	16.0	16	32	44	92	15	5	0.20	€ 57,50
GAA26180	18.0	16	32	-	92	-	6	0.20	€ 62,00
GAA26200	20.0	20	38	54	104	19	6	0.20	€ 80,00
GAA26250	25.0	25	45	63	121	24	6	0.20	€ 117,50

**COMPLETE SET:
6 + 8 + 10 + 12 + 16mm**

**ACTIE
€ 189,-**

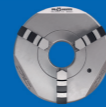

**THE DURO-M
FROM RÖHM.**

**IF YOU'RE LOOKING FOR
A LATHE CHUCK THAT WILL
TAKE YOU THE DISTANCE.**

Choosing a DURO-M is the beginning of a long friendship. For clamping turned parts on manual turning machines.



RÖHM



**SMARTER
CLAMPING.**

The clamping jaw that can also measure. The measuring instrument that can also clamp. **THE iJAW. FROM RÖHM.**



RÖHM

**COMPLEET ASSORTIMENT
WERKPLAATS UITRUSTING**

Young cuttingtools is dealer van het Duitse Bedrunka+Hirth, een toonaangevende fabrikant van een compleet gamma werkplaatsinrichtingen van oerdegelijke Duitse kwaliteit. Zij bieden een zeer ruim assortiment, waaronder:

- LADENKASTEN
- CNC- OPBERGKASTEN
- INDELINGSMATERIAAL
- WERKBANKEN, VAST OF MOBIEL, MET SYSTEEMWANDEN
- COMPUTERKASTEN
- ERGONOMISCHE WERKSTATIONS



**MEEST
VERKOCHT**



VRAAG VOOR MEER
INFORMATIE NAAR
DE CATALOGUS VAN
BEDRUNKA HIRTH

*"Een praktische werkplaatsuitrusting
is een must voor iedereen die vaak
metaal bewerkt"*



bedrunka+hirth

Workplace up to date – mehr Raum zum Arbeiten

3-PUNT BINNENMICROMETER

- Meet DIN863-4
- 6-12mm: nauwkeurigheid 0.001mm
- 12-200mm: nauwkeurigheid 0.005mm
- Ratel stop

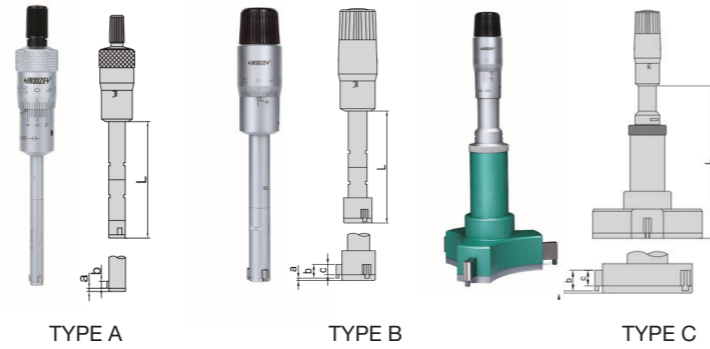

Artikel nummer	range	Type	Nauwkeurigheid	Instel ring (inclusief)	Verlenghuls	L	A	B	C	Actieprijs
3227-8*	6-8mm	A	4µm	Ø6mm (inclusief)	100mm	54.5	1.5	2.5	-	€ 225,00
3227-10*	8-10mm	A	4µm	Ø8mm (inclusief)	100mm	54.5	1.5	2.5	-	€ 225,00
3227-12*	10-12mm	A	4µm	Ø10mm (inclusief)	100mm	54.5	1.5	2.5	-	€ 225,00
3227-16*	12-16mm	B	4µm	Ø16mm (inclusief)	150mm	80	0.5	6	4.5	€ 179,00
3227-20*	16-20mm	B	4µm	Ø16mm (inclusief)	150mm	80	0.5	6	4.5	€ 179,00
3227-25*	20-25mm	B	4µm	Ø25mm (inclusief)	150mm	90	0.5	8	6	€ 235,00
3227-30*	25-30mm	B	4µm	Ø25mm (inclusief)	150mm	90	0.5	8	6	€ 235,00
3227-40*	30-40mm	B	4µm	Ø40mm (inclusief)	150mm	97	0.5	14	12	€ 268,00
3227-50*	40-50mm	B	5µm	Ø40mm (inclusief)	150mm	97	0.5	14	12	€ 291,00
3227-63*	50-63mm	C	5µm	Ø62mm (inclusief)	150mm	114	0.5	17.5	14.5	€ 323,00
3227-75*	62-75mm	C	5µm	Ø62mm (inclusief)	150mm	114	0.5	17.5	14.5	€ 334,00
3227-88*	75-88mm	C	5µm	Ø87mm (inclusief)	150mm	114	0.5	17.5	14.5	€ 351,00
3227-100*	87-100mm	C	5µm	Ø87mm (inclusief)	150mm	114	0.5	17.5	14.5	€ 369,00
3227-125*	100-125mm	C	5µm	Optie	150mm	140	0.9	29	25	€ 462,00
3227-150*	125-150mm	C	5µm	Optie	150mm	140	0.9	29	25	€ 523,00
3227-175*	150-175mm	C	7µm	Optie	150mm	140	0.9	29	25	€ 579,00
3227-200*	175-200mm	C	7µm	Optie	150mm	140	0.9	29	25	€ 669,00



INSTELRING
6-100mm: inclusief
100-200mm: optioneel



VERLENGHULS
inclusief

Artikel nummer	Range	Inbegrepen Micrometers	Instel ring (inclusief)	Verlenghuls (inclusief)	Actieprijs
3227-123*	6-12mm	6-8mm, 8-10mm, 10-12mm	Ø6mm, Ø8mm, Ø10mm	100mm	€ 532,00
3227-202*	12-20mm	12-16mm, 16-20mm	Ø16mm	150mm	€ 311,00
3227-504*	20-50mm	20-25mm, 25-30mm, 30-40mm, 40-50mm	Ø25mm, Ø40mm	150mm	€ 736,00
3227-1004*	50-100mm	50-63mm, 62-75mm, 75-88mm, 87-100mm	Ø62mm, Ø87mm	150mm	€ 1.051,00

*Geleverd met inspectiecertificaat van de fabrikant

LAMELENSCHIJF 125 MM CONISCH, ZIRKONIUM

- Asgat 22,22 mm
- Geschikt voor staal en RVS



Artikel nummer	Korrel	Bij afname 10 stuks prijs p/st	Bij afname 50 stuks prijs p/st
45027380.040	Korrel 40	€ 1,79 *	€ 1,49 *
45027380.060	Korrel 60	€ 1,79 *	€ 1,49 *

DOORSLIJPSCHIJF 125X1.0MM

- Asgat 22,22 mm
- Geschikt voor staal en RVS



Artikel nummer	Korrel	Bij afname 100 stuks prijs p/st
4502126.0125	Korrel 40	€ 0,69

FORMAT HANDSCHOEN BLADE CLASSIC-3

- Vloeistofbestendige, duurzame coating
- Naadloos gebreid
- Zeer dun en elastisch materiaal
- Standaard: EN 388 (4.3.4.3), EN 407
- Plaat- en glasbewerking, automobielenindustrie
- Materiaal: polyurethaan coating
- Hoogwaardige polyethyleen vezel



Artikel nummer	maat voering	Prijs p/st
8003614.0700	7 t/m 11	€ 3,75

Verpakking per 10 stuks

NITRAS NYLON HANDSCHOENEN

- Grijs
- PU-coating
- Gebreide tailleband
- Gedeeltelijk gecoat op handpalm en vingertoppen



Artikel nummer	maat voering	Prijs p/st
8003013.0700	7 t/m 11	€ 0,95

Verpakking per 10 stuks

UVEX VEILIGHEIDSBRIL BLAUWGRIJS

- Sluit betrouwbaar af en beschermt tegen rondvliegende deeltjes
- In lengte verstelbare beugel
- Gecoat met uvex supervision excellence
- Ten minste 16 seconden geen condens
- Extreem krasvast aan de buitenkant
- Chemicaliënbestendig
- Frame in blauwgrijs



Artikel nummer	Prijs p/st
8002787.0100	€ 9,95

SCHUIFMAAT



- Nauwkeurigheid: ±0.03mm
- IP67 stof/waterdicht
- Aflezing: 0.01mm

Artikel nummer	Range	Rolknop	Type	prijs
1118-150BW*	0-150mm	geen rolknop	B	€ 82,50
1118-150B*	0-150mm	met rolknop	B	

ONZE MERKEN



"Door middel van het geven van gerichte adviezen over toepassing en gebruik van de juiste gereedschappen is Young cuttingtools uw partner voor efficiënter produceren in de metaalbewerkingbranche."



YOUNG CUTTINGTOOLS BV

Meerheide 100b
5521 DX Eersel
Postbus 60
5520 AB Eersel

Tel. +31 (0)497-820213
Fax +31 (0)497-820214
info@youngcuttingtools.nl
www.youngcuttingtools.nl

VOLG ONS

